

# Product data sheet

Specifications



Illuminated selector switch,  
Harmony XB4, metal, green handle,  
22mm, universal LED, 2 positions,  
1NO + 1NC, 230...240V AC

XB4BK123M5

**Important message: A change in appearance may be noted on the product but does not affect its use in terms of function and safety. This makes it compatible with our Universal LED blocks**

## Main

Range of product	Harmony XB4
Product or component type	Illuminated selector switch
Device short name	XB4
Bezel material	Chromium plated metal
Fixing collar material	Zamak
Head type	Standard
Mounting diameter	22.5 mm
Sale per indivisible quantity	1
Shape of signaling unit head	Round
Type of operator	stay put
Operator profile	Green standard handle
Operator position information	2 positions 90°
Contacts type and composition	1 NO + 1 NC
Contact operation	Slow-break
Connections - terminals	Screw clamp terminals, <= 2 x 1.5 mm <sup>2</sup> with cable end conforming to IEC 60947-1 Screw clamp terminals, >= 1 x 0.22 mm <sup>2</sup> without cable end conforming to IEC 60947-1
Light source	Universal LED
Bulb base	Integral LED
[Us] rated supply voltage	230...240 V AC at 50/60 Hz

## Complementary

Height	47 mm
Width	30 mm
Depth	68 mm
Terminals description ISO n°1	(21-22)NC (13-14)NO
Net weight	0.111 kg
Resistance to high pressure washer	7000000 Pa at 55 °C, distance : 0.1 m
Contacts usage	Standard contacts
Positive opening	With conforming to IEC 60947-5-1 appendix K

<b>Operating torque</b>	0.14 N.m NO changing electrical state
<b>Mechanical durability</b>	1000000 cycles
<b>Tightening torque</b>	0.8...1.2 N.m conforming to IEC 60947-1
<b>Shape of screw head</b>	Cross compatible with Philips no 1 screwdriver Cross compatible with pozidriv No 1 screwdriver Slotted compatible with flat Ø 4 mm screwdriver Slotted compatible with flat Ø 5.5 mm screwdriver
<b>Contacts material</b>	Silver alloy (Ag/Ni)
<b>Short-circuit protection</b>	10 A cartridge fuse type gG conforming to IEC 60947-5-1
<b>[Ith] conventional free air thermal current</b>	10 A conforming to IEC 60947-5-1
<b>[Ui] rated insulation voltage</b>	600 V (pollution degree 3) conforming to IEC 60947-1
<b>[Uimp] rated impulse withstand voltage</b>	6 kV conforming to IEC 60947-1
<b>[Ie] rated operational current</b>	3 A at 240 V, AC-15, A600 conforming to IEC 60947-5-1 6 A at 120 V, AC-15, A600 conforming to IEC 60947-5-1 0.1 A at 600 V, DC-13, Q600 conforming to IEC 60947-5-1 0.27 A at 250 V, DC-13, Q600 conforming to IEC 60947-5-1 0.55 A at 125 V, DC-13, Q600 conforming to IEC 60947-5-1 1.2 A at 600 V, AC-15, A600 conforming to IEC 60947-5-1
<b>Electrical durability</b>	1000000 cycles, AC-15, 2 A at 230 V, operating rate <3600 cyc/h, load factor: 0.5 conforming to EN 60947-5-1 appendix C 1000000 cycles, AC-15, 3 A at 120 V, operating rate <3600 cyc/h, load factor: 0.5 conforming to EN 60947-5-1 appendix C 1000000 cycles, AC-15, 4 A at 24 V, operating rate <3600 cyc/h, load factor: 0.5 conforming to EN 60947-5-1 appendix C 1000000 cycles, DC-13, 0.2 A at 110 V, operating rate <3600 cyc/h, load factor: 0.5 conforming to EN 60947-5-1 appendix C 1000000 cycles, DC-13, 0.5 A at 24 V, operating rate <3600 cyc/h, load factor: 0.5 conforming to EN 60947-5-1 appendix C
<b>Electrical reliability</b>	$\Lambda < 10\exp(-6)$ at 5 V and 1 mA in clean environment conforming to IEC 60947-5-4 $\Lambda < 10\exp(-8)$ at 17 V and 5 mA in clean environment conforming to IEC 60947-5-4
<b>Signalling type</b>	Steady
<b>Supply voltage limits</b>	195...264 V AC
<b>Current consumption</b>	14 mA
<b>Service life</b>	100000 h at rated voltage and 25 °C
<b>Surge withstand</b>	1 kV conforming to IEC 61000-4-5
<b>Device presentation</b>	Complete product

## Environment

<b>Protective treatment</b>	TH
<b>Ambient air temperature for storage</b>	-40...70 °C
<b>Ambient air temperature for operation</b>	-40...70 °C
<b>Electrical shock protection class</b>	Class I conforming to IEC 60536
<b>IP degree of protection</b>	IP66 conforming to IEC 60529 IP67 IP69 IP69K
<b>NEMA degree of protection</b>	NEMA 13 NEMA 4X
<b>IK degree of protection</b>	IK04 conforming to IEC 50102

<b>Standards</b>	IEC 60947-1 JIS C8201-5-1 CSA C22.2 No 14 IEC 60947-5-4 IEC 60947-5-1 UL 508 IEC 60947-5-5 JIS C8201-1
<b>Product certifications</b>	BV UL CSA DNV LROS (Lloyds register of shipping)
<b>Vibration resistance</b>	5 gn (f= 2...500 Hz) conforming to IEC 60068-2-6
<b>Shock resistance</b>	30 gn (duration = 18 ms) for half sine wave acceleration conforming to IEC 60068-2-27 50 gn (duration = 11 ms) for half sine wave acceleration conforming to IEC 60068-2-27
<b>Resistance to fast transients</b>	2 kV conforming to IEC 61000-4-4
<b>Resistance to electromagnetic fields</b>	10 V/m conforming to IEC 61000-4-3
<b>Resistance to electrostatic discharge</b>	6 kV on contact (on metal parts) conforming to IEC 61000-4-2 8 kV in free air (in insulating parts) conforming to IEC 61000-4-2
<b>Electromagnetic emission</b>	Class B conforming to IEC 55011

## Packing Units

<b>Unit Type of Package 1</b>	PCE
<b>Number of Units in Package 1</b>	1
<b>Package 1 Height</b>	3.900 cm
<b>Package 1 Width</b>	5.400 cm
<b>Package 1 Length</b>	9.100 cm
<b>Package 1 Weight</b>	109.000 g
<b>Unit Type of Package 2</b>	S03
<b>Number of Units in Package 2</b>	100
<b>Package 2 Height</b>	30.000 cm
<b>Package 2 Width</b>	30.000 cm
<b>Package 2 Length</b>	40.000 cm
<b>Package 2 Weight</b>	11.457 kg
<b>Unit Type of Package 3</b>	P06
<b>Number of Units in Package 3</b>	800
<b>Package 3 Height</b>	75.000 cm
<b>Package 3 Width</b>	60.000 cm
<b>Package 3 Length</b>	80.000 cm
<b>Package 3 Weight</b>	103.004 kg

## Contractual warranty

<b>Warranty</b>	18 months
-----------------	-----------



## Environmental Data

Schneider Electric aims to achieve Net Zero status by 2050 through supply chain partnerships, lower impact materials, and circularity via our ongoing “Use Better, Use Longer, Use Again” campaign to extend product lifetimes and recyclability.

[Environmental Data explained >](#)

[How we assess product sustainability >](#)

### Environmental footprint

Carbon footprint (kg.eq.CO2 per CR, Total Life cycle) 92

Environmental Disclosure [Product Environmental Profile](#)

## Use Better

### Materials and Substances

[EU RoHS Directive](#) Pro-active compliance (Product out of EU RoHS legal scope)

REACH Regulation [REACH Declaration](#)

China RoHS Regulation [China RoHS declaration](#)

California proposition 65 **WARNING: This product can expose you to chemicals including: Lead and lead compounds, which is known to the State of California to cause cancer and birth defects or other reproductive harm. For more information go to [www.P65Warnings.ca.gov](http://www.P65Warnings.ca.gov)**

## Use Again

### Repack and remanufacture

Circularity Profile [End of Life Information](#)

WEEE  The product must be disposed on European Union markets following specific waste collection and never end up in rubbish bins

Take-back No

Dimensions Drawings

Dimensions

---

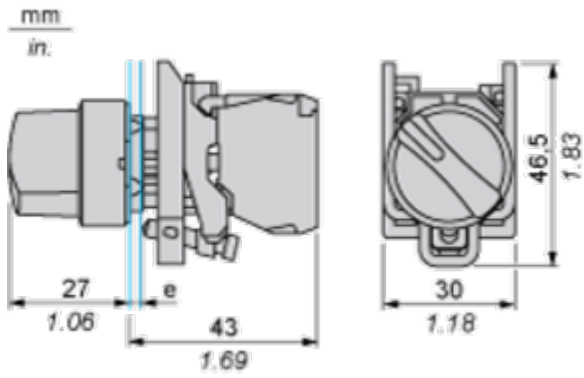

e : clamping thickness: 1 to 6 mm / 0.04 to 0.24 in.

Mounting and Clearance

**Panel Cut-out for Pushbuttons, Switches and Pilot Lights (Finished Holes, Ready for Installation)**

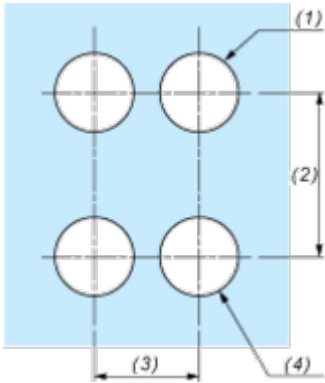
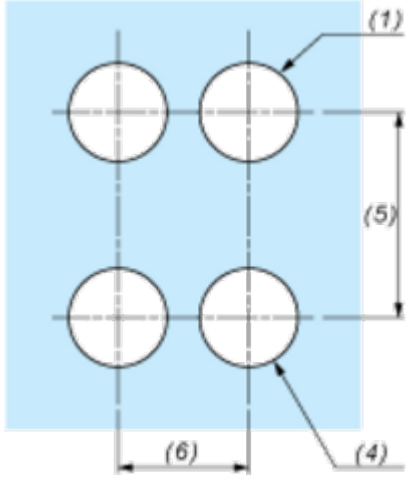
Connection by Screw Clamp Terminals or Plug-in Connectors or on Printed Circuit Board	Connection by Faston Connectors
	
<p>(1) Diameter on finished panel or support                  (2) 40 mm min. / 1.57 in. min.                  (3) 30 mm min. / 1.18 in. min.                  (4) <math>\varnothing 22.5 \text{ mm} / 0.89 \text{ in. recommended } (\varnothing 22.3 \text{ mm }_0^{+0.4} / 0.88 \text{ in. }_0^{+0.016})</math>                  (5) 45 mm min. / 1.78 in. min.                  (6) 32 mm min. / 1.26 in. min.</p>	

Technical Illustration

Dimensions

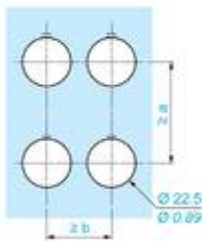
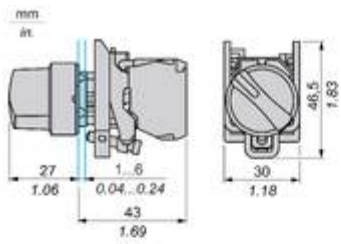

		a (mm)	a (in.)	b (mm)	b (in.)
		40	1.57	30	1.18
ZBE.....	ZBV.....				
		45	1.77	32	1.26
ZBE.....3	ZBV.....3				
		40	1.57	30	1.18
ZBE.....4	ZBV.....4				
		50	1.97	30	1.18
ZBE.....5	ZBV.....5				
		40	1.57	30	1.18
ZBE.....9	ZBV.....9				
		40	1.57	30	1.18
ZBRT..	ZBRV1				

Offer Marketing Illustration

Product benefits / Features

---

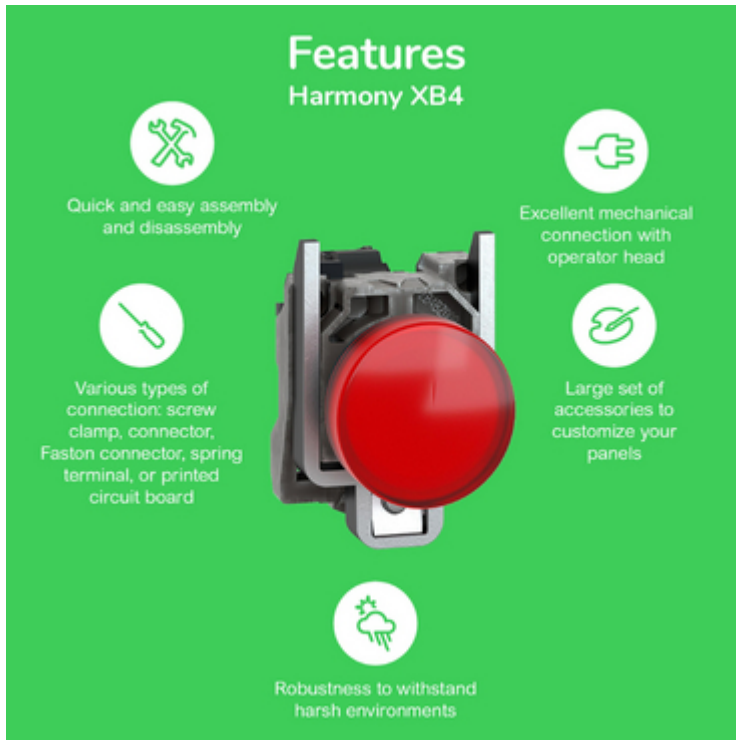

The infographic features a central image of a red push-button switch. Surrounding it are five circular icons, each with a corresponding text description of a feature. The background is a solid green color.

### Features Harmony XB4





-  Quick and easy assembly and disassembly
-  Various types of connection: screw clamp, connector, Faston connector, spring terminal, or printed circuit board
-  Excellent mechanical connection with operator head
-  Large set of accessories to customize your panels
-  Robustness to withstand harsh environments

Image of product / Alternate images

Alternative

---

